

# 4" SUBMERSIBLE PUMPS

C A T A L O G U E



**60Hz** 4" SUBMERSIBLE PUMPS  
4" DALGIÇ POMPA



## Genel Özellikler

### General Features

- Maksimum kapasite 24 m<sup>3</sup>/saat  
*Capacity up to 24 m<sup>3</sup>/h*
- Maksimum motor gücü 7.5 Kw  
*Rated motor power output up to 7.5 Kw*
- Maksimum su sıcaklığı 35°C  
*Maximum water temperature 35 °C*
- Maksimum pompa çapı 98 mm (Kablo koruması dahil)  
*Maximum overall pump diameter 98 mm (Including cable guard)*
- Kabul edilebilir maksimum kum miktarı 50g / m<sup>3</sup>  
*Maximum permissible quantity of suspended sand of 50g/m<sup>3</sup>*
- Çıkış Bağlantısı > 1¼", 1½", 2"  
*Discharge Connection > 1¼", 1½", 2"*



**4" DALGIÇ POMPALAR**

4" SUBMERSIBLE PUMPS

**60Hz**





4" Dalgıç Pompa Yedek Parçaları / 4" Submersible Pump Spare Parts

## Ürün Kodu Sistemi

Product Code System

VSP SN 4 001 / 19

Kademe sayısı / Number of stages

Nominal debi / Nominal capacity (m<sup>3</sup>/h)

Anma çapı / Nominal diameter (40: 4 inch)

Çark malzemesi / Impeller material (N: noryl)

Difüzör malzemesi / Diffuser material (S: stainless steel)

Pompa tipi / Pump type (VSP: Vansan submersible pump)

No	Parça Adı / Part Name	Malzeme / Material
1	Çıkış Haznesi / Discharge Head	Paslanmaz Döküm (AISI 304) / Casted Stainless Steel (AISI 304)
2	Klepe Diski / Valve Disc	Paslanmaz Çelik (AISI 304) / Stainless Steel (AISI 304)
3	Klepe Oturma Çemberi / Valve Seat Retainer	Paslanmaz Çelik (AISI 304) / Stainless Steel (AISI 304)
4	Klepe Oturma Diski / Valve Seat	Paslanmaz Çelik (AISI 304) / Stainless Steel (AISI 304)
5	Çıkış Haznesi Segmanı / Valve Locking Ring	Paslanmaz Çelik (AISI 304) / Stainless Steel (AISI 304)
6	Ara Parça Çemberi / Adapter Ring	Noril / Noryl
7	Ara Parça Burcu / Bushing	Noril / Noryl
8	Ara Parça Yatağı / Bearing Spacer	Poliüretan / Polyurethane
9	Ara Parça / Valve Housing	Noril / Noryl
10	Difüzör / Diffuser	PC, %20 Cam Elyaf Takviyeli, Naturel / PC, 20% Glass Fiber Reinforced, Natural
11	Çark / Impeller	Noril / Noryl
12	Difüzör Haznesi / Diffuser Casing	Paslanmaz Çelik (AISI 304) / Stainless Steel (AISI 304)
13	Pul / Shim	Paslanmaz Çelik (AISI 304) / Stainless Steel (AISI 304)
14	Emiş Haznesi / Suction Case	Paslanmaz Çelik (AISI 304) / Stainless Steel (AISI 304)
15	Süzgeç / Strainer	Paslanmaz Çelik (AISI 304) / Stainless Steel (AISI 304)
16	O-Ring / O-ring	Kauçuk / Rubber
17	Kaplin / Coupling	Paslanmaz Çelik (AISI 316) / Stainless Steel (AISI 316)
18	Mil / Shaft	Paslanmaz Çelik (AISI 420) / Stainless Steel (AISI 420)
19	Rondela / Washer	Paslanmaz Çelik (AISI 304) / Stainless Steel (AISI 304)
20	Pul / Shim	Paslanmaz Çelik (AISI 304) / Stainless Steel (AISI 304)
21	Kılıf Borusu / Pump Casing	Paslanmaz Çelik (AISI 304) / Stainless Steel (AISI 304)
22	Kablo Koruma / Cable Guard	Paslanmaz Çelik (AISI 304) / Stainless Steel (AISI 304)

# Teknik Çizim

Technical Drawing

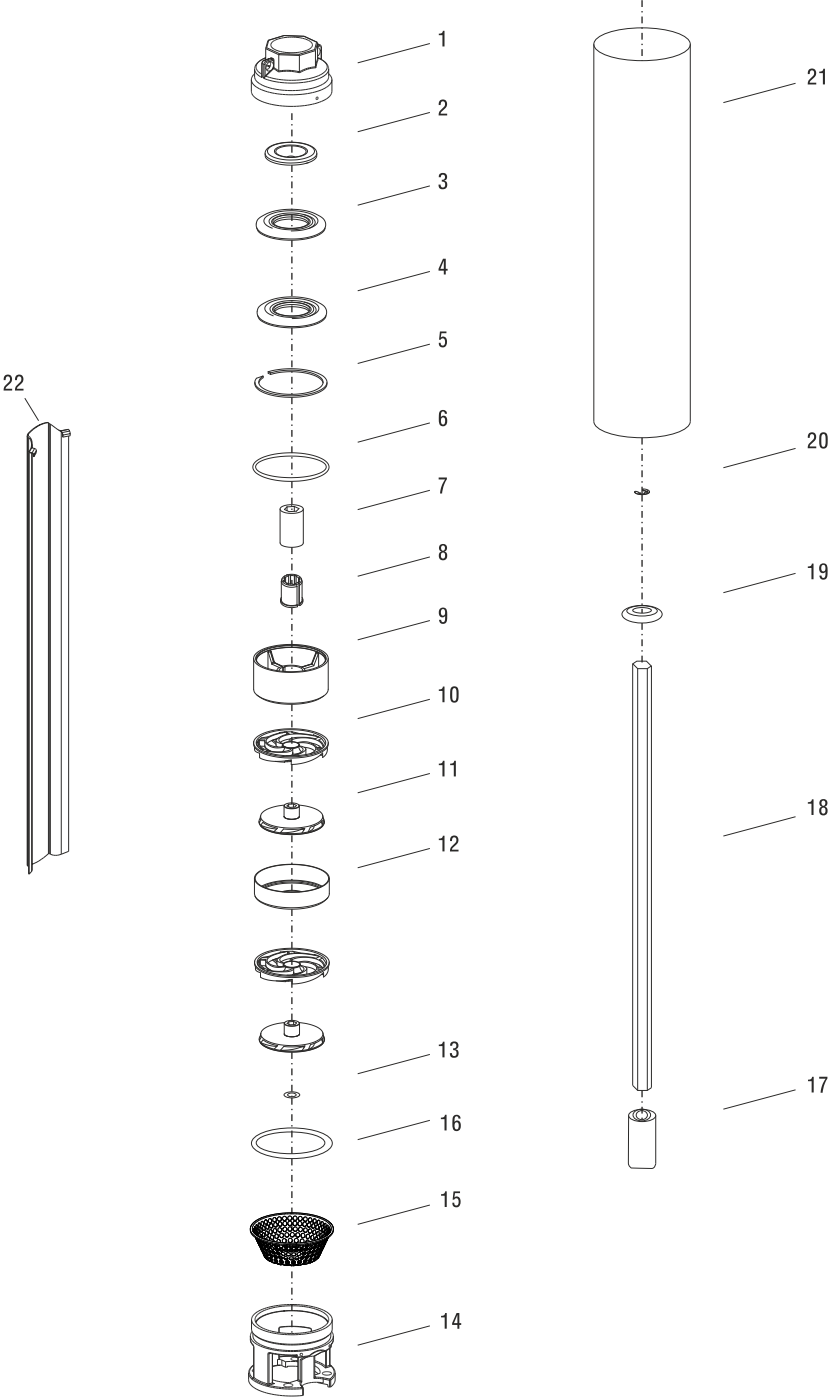

# Teknik Özellikler

## Technical specifications

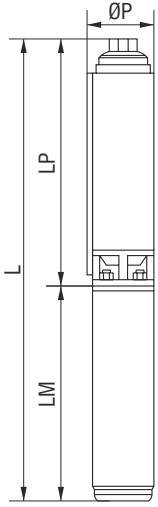

**Çark** : Noril  
**Impeller** : Noryl

**Difüzör** : PC, %20 Cam Elyaf Takviyeli, Naturel  
**Diffuser** : PC, 20% Glass Fiber Reinforced, Natural

**Süzgeç** : Paslanmaz çelik (AISI 304)  
**Strainer** : Stainless steel (AISI 304)

**Kaplin** : Paslanmaz çelik (AISI 316)  
**Coupling** : Stainless steel (AISI 316)

**Klepe** : Paslanmaz çelik (AISI 304)  
**Valve cap** : Stainless steel (AISI 304)

**Ara parça** : Noril  
**Valve Housing** : Noryl

**Pompa mili** : Paslanmaz çelik (AISI 420)  
**Pump shaft** : Stainless steel (AISI 420)

**Emiş haznesi** : Paslanmaz çelik (AISI 304)  
**Suction case** : Stainless steel (AISI 304)

**Çıkış haznesi** : Paslanmaz çelik (AISI 304)  
**Top bracket** : Stainless steel (AISI 304)

**Difüzör haznesi** : Paslanmaz çelik (AISI 304)  
**Diffuser casing** : Stainless steel (AISI 304)



## Ölçü ve Ağırlıklar / Dimensions & Weights

Pompa Tipi Pump type	Kad. Sayısı Stages	Motor		Ölçüler / Dimensions (mm)						Ağırlık / Weight (kg)				
		kW	HP	ØP	LP	Monofaze / 1ph.		Trifaze / 3ph.		Pompa Pump	Monofaze / 1ph.		Trifaze / 3ph.	
						LM	L	LM	L		Motor	Total	Motor	Total
VSP SN 04005/9	9	0,37	0,5	98	309	361	670	346	655	3,1	8,6	11,7	7,7	10,8
VSP SN 04005/12	12	0,37	0,5	98	363	361	724	346	709	3,6	8,6	12,2	7,7	11,3
VSP SN 04005/15	15	0,55	0,75	98	415	381	796	361	776	4,1	9,3	13,4	8,5	12,6
VSP SN 04005/20	20	0,75	1	98	504	401	905	381	885	4,9	10,4	15,3	9,5	14,4
VSP SN 04005/26	26	1,1	1,5	98	648	441	1.089	401	1.049	5,8	12,2	18,0	10,4	16,2
VSP SN 04005/33	33	1,5	2	98	803	471	1.274	441	1.244	8,3	13,7	22,0	12,4	20,7

## Performans Tablosu / Performance Table

Pompa Tipi Pump type	Kad. Sayısı Stages	Motor		m <sup>3</sup> /h l/min	0	0,3	0,6	0,9	1,2	1,32	1,5	1,62	1,8
		kW	HP		0	5	10	15	20	22	25	27	30
VSP SN 04005/9	9	0,37	0,5	Basma Yüksekliği / Head (m)	86	79	72	63	52	46	37	30	18
VSP SN 04005/12	12	0,37	0,5		114	105	96	85	69	62	49	40	24
VSP SN 04005/15	15	0,55	0,75		143	132	120	106	87	77	61	50	30
VSP SN 04005/20	20	0,75	1		190	175	160	141	116	103	82	66	39
VSP SN 04005/26	26	1,1	1,5		248	228	208	183	150	134	107	86	51
VSP SN 04005/33	33	1,5	2		314	289	264	233	191	170	135	109	65



## Performans Eğrileri / Performance Curves

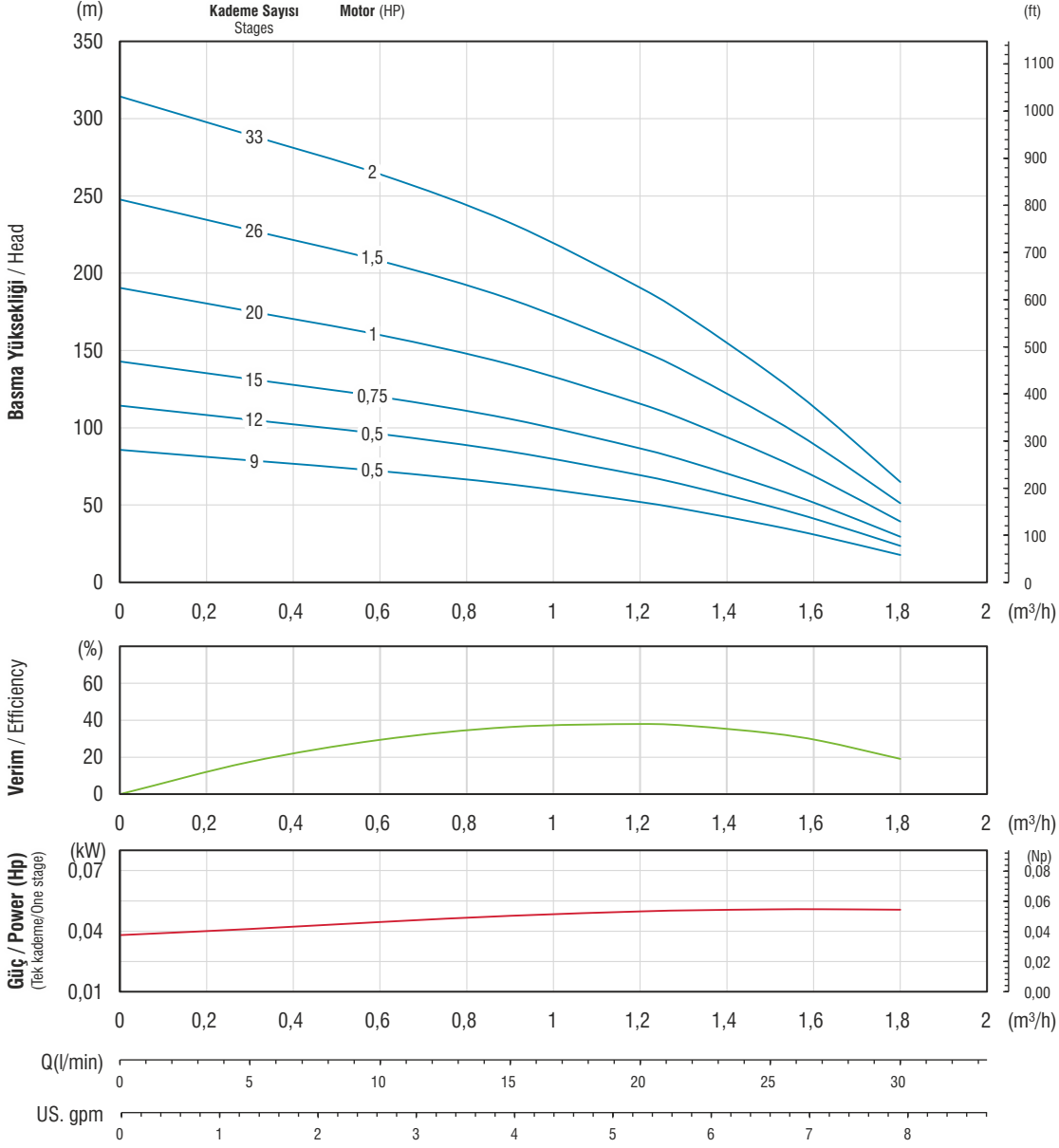

www.vansan.com.tr

# VSP SN 04005 (60Hz)

Çark kanat sayısı / No. of vanes  
6

Çıkış haznesi bağlantısı / Outlet connection diameter  
BSP / NPT 1½"

Pompa dış çapı / Pump outside diameter  
98 mm (kablo koruması dahil / Including cable guard)

Dönüş Yönü / Rotation  
Saatin tersi yönünde / CCW

Devir / Revolution  
3500 rpm

Mil çapı / Shaft diameter  
11 mm

Pompa performans eğrileri 1 bar atmosfer basıncı altında 15°C sıcaklığındaki, özgül yoğunluğu 1 gr/cm³ olan su ile elde edilmiştir.  
The hydraulic working characteristics have been taken with water at 15 °C, at the atmospheric pressure of 1 bar and specific gravity is 1 gr/cm³



# Teknik Özellikler

## Technical specifications

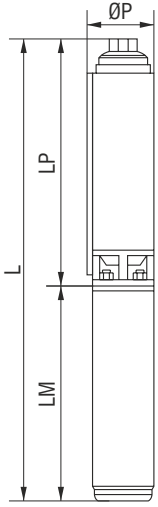

**Çark** : Noril  
**Impeller** : Noryl

**Difüzör** : PC, %20 Cam Elyaf Takviyeli, Naturel  
**Diffuser** : PC, 20% Glass Fiber Reinforced, Natural

**Süzgeç** : Paslanmaz çelik (AISI 304)  
**Strainer** : Stainless steel (AISI 304)

**Kaplin** : Paslanmaz çelik (AISI 316)  
**Coupling** : Stainless steel (AISI 316)

**Klepe** : Paslanmaz çelik (AISI 304)  
**Valve cap** : Stainless steel (AISI 304)

**Ara parça** : Noril  
**Valve Housing** : Noryl

**Pompa mili** : Paslanmaz çelik (AISI 420)  
**Pump shaft** : Stainless steel (AISI 420)

**Emiş haznesi** : Paslanmaz çelik (AISI 304)  
**Suction case** : Stainless steel (AISI 304)

**Çıkış haznesi** : Paslanmaz çelik (AISI 304)  
**Top bracket** : Stainless steel (AISI 304)

**Difüzör haznesi** : Paslanmaz çelik (AISI 304)  
**Diffuser casing** : Stainless steel (AISI 304)



## Ölçü ve Ağırlıklar / Dimensions & Weights

Pompa Tipi Pump type	Kad. Sayısı Stages	Motor		Ölçüler / Dimensions (mm)						Ağırlık / Weight (kg)				
		kW	HP	ØP	LP	Monofaze / 1ph.		Trifaze / 3ph.		Pompa Pump	Monofaze / 1ph.		Trifaze / 3ph.	
						LM	L	LM	L		Motor	Total	Motor	Total
VSP SN 04010/5	5	0,37	0,5	98	234	361	595	346	580	2,5	8,6	11,1	7,7	10,2
VSP SN 04010/7	7	0,37	0,5	98	268	361	629	346	614	2,8	8,6	11,4	7,7	10,5
VSP SN 04010/10	10	0,55	0,75	98	321	381	702	361	682	3,3	9,3	12,6	8,5	11,8
VSP SN 04010/12	12	0,75	1	98	355	401	756	381	736	3,6	10,4	14,0	9,5	13,1
VSP SN 04010/17	17	1,1	1,5	98	443	441	884	401	844	4,4	12,2	16,6	10,4	14,8
VSP SN 04010/20	20	1,5	2	98	494	471	965	441	935	4,9	13,7	18,6	12,4	17,3
VSP SN 04010/27	27	2,2	3	98	653	561	1.214	471	1.124	6,0	18,0	24,0	13,9	19,9
VSP SN 04010/37	37	3	4	98	856	-	-	530	1.386	9,0	-	-	16,2	25,2
VSP SN 04010/48	48	3,7	5	98	1.083	-	-	595	1.678	10,8	-	-	19,5	30,3

## Performans Tablosu / Performance Table

Pompa Tipi Pump type	Kad. Sayısı Stages	Motor		m <sup>3</sup> /h l/min	0	0,6	1,5	1,8	2,1	2,4	3,0	3,6	4,2
		kW	HP		0	10	25	30	35	40	50	60	70
VSP SN 04010/5	5	0,37	0,5	Basma Yüksekliği / Head (m)	49	47	43	41	38	35	29	21	13
VSP SN 04010/7	7	0,37	0,5		69	66	60	57	53	50	40	29	18
VSP SN 04010/10	10	0,55	0,75		98	94	85	81	76	71	58	42	25
VSP SN 04010/12	12	0,75	1		117	113	102	97	92	85	69	51	30
VSP SN 04010/17	17	1,1	1,5		166	159	145	138	130	120	98	72	43
VSP SN 04010/20	20	1,5	2		196	188	170	162	153	142	115	84	50
VSP SN 04010/27	27	2,2	3		274	263	238	227	214	198	162	118	70
VSP SN 04010/37	37	3	4		362	347	315	300	282	262	213	156	93
VSP SN 04010/48	48	3,7	5		470	450	409	389	366	340	277	202	120

## Performans Eğrileri / Performance Curves

www.vansan.com.tr

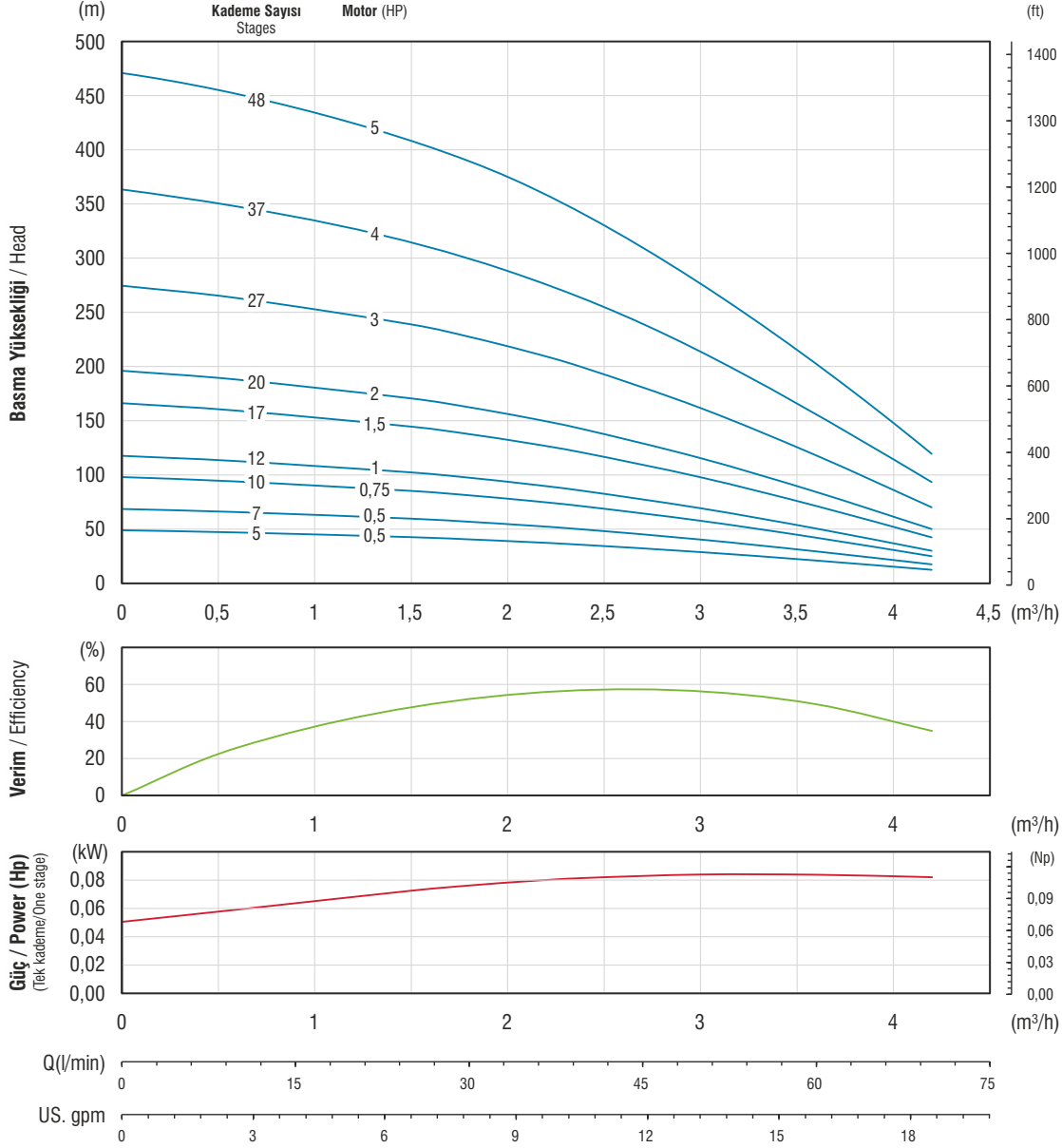

# VSP SN 04010 (60Hz)

Çark kanat sayısı / No. of vanes  
7

Çıkış haznesi bağlantısı / Outlet connection diameter  
BSP / NPT 1¼"

Pompa dış çapı / Pump outside diameter  
98 mm (kablo koruması dahil / Including cable guard)

Dönüş Yönü / Rotation  
Saatin tersi yönünde / CCW

Devir / Revolution  
3500 rpm

Mil çapı / Shaft diameter  
11 mm



Pompa performans eğrileri 1 bar atmosfer basıncı altında 15°C sıcaklığındaki, özgül yoğunluğu 1 gr/cm³ olan su ile elde edilmiştir.  
The hydraulic working characteristics have been taken with water at 15°C, at the atmospheric pressure of 1 bar and specific gravity is 1 gr/cm³

# Teknik Özellikler

## Technical specifications

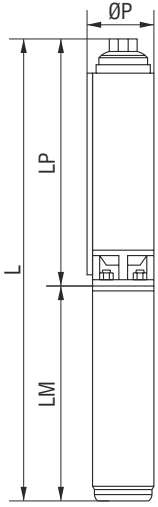

**Çark** : Noril  
**Impeller** : Noryl

**Difüzör** : PC, %20 Cam Elyaf Takviyeli, Naturel  
**Diffuser** : PC, 20% Glass Fiber Reinforced, Natural

**Süzgeç** : Paslanmaz çelik (AISI 304)  
**Strainer** : Stainless steel (AISI 304)

**Kaplin** : Paslanmaz çelik (AISI 316)  
**Coupling** : Stainless steel (AISI 316)

**Klepe** : Paslanmaz çelik (AISI 304)  
**Valve cap** : Stainless steel (AISI 304)

**Ara parça** : Noril  
**Valve Housing** : Noryl

**Pompa mili** : Paslanmaz çelik (AISI 420)  
**Pump shaft** : Stainless steel (AISI 420)

**Emiş haznesi** : Paslanmaz çelik (AISI 304)  
**Suction case** : Stainless steel (AISI 304)

**Çıkış haznesi** : Paslanmaz çelik (AISI 304)  
**Top bracket** : Stainless steel (AISI 304)

**Difüzör haznesi** : Paslanmaz çelik (AISI 304)  
**Diffuser casing** : Stainless steel (AISI 304)



## Ölçü ve Ağırlıklar / Dimensions & Weights

Pompa Tipi Pump type	Kad. Sayısı Stages	Motor		Ölçüler / Dimensions (mm)						Ağırlık / Weight (kg)				
		kW	HP	ØP	LP	Monofaze / 1ph.		Trifaze / 3ph.		Pompa Pump	Monofaze / 1ph.		Trifaze / 3ph.	
						LM	L	LM	L		Motor	Total	Motor	Total
VSP SN 04015/5	5	0,37	0,5	98	231	361	592	346	577	2,6	8,6	11,2	7,7	10,3
VSP SN 04015/7	7	0,55	0,75	98	266	381	647	361	627	2,9	9,3	12,2	8,5	11,4
VSP SN 04015/10	10	0,75	1	98	318	401	719	381	699	3,3	10,4	13,7	9,5	12,8
VSP SN 04015/12	12	1,1	1,5	98	352	441	793	401	753	3,6	12,2	15,8	10,4	14,0
VSP SN 04015/17	17	1,5	2	98	438	471	909	441	879	4,4	13,7	18,1	12,4	16,8
VSP SN 04015/21	21	2,2	3	98	509	561	1.070	471	980	5,2	18,0	23,2	13,9	19,1
VSP SN 04015/28	28	3	4	98	665	-	-	530	1.195	6,2	-	-	16,2	22,4
VSP SN 04015/35	35	3,7	5	98	824	-	-	595	1.419	8,9	-	-	19,5	28,4

## Performans Tablosu / Performance Table

Pompa Tipi Pump type	Kad. Sayısı Stages	Motor		m <sup>3</sup> /h l/min	0	1,2	2,1	2,7	3,0	3,6	4,2	4,5	4,8
		kW	HP		0	20	35	45	50	60	70	75	80
VSP SN 04015/5	5	0,37	0,5	Basma Yüksekliği / Head (m)	48	47	44	40	38	33	27	24	20
VSP SN 04015/7	7	0,55	0,75		67	65	61	56	54	47	38	33	28
VSP SN 04015/10	10	0,75	1		95	93	87	81	77	67	54	47	40
VSP SN 04015/12	12	1,1	1,5		114	112	105	97	92	80	65	57	48
VSP SN 04015/17	17	1,5	2		162	158	148	137	130	113	93	81	68
VSP SN 04015/21	21	2,2	3		200	196	183	169	161	140	114	100	84
VSP SN 04015/28	28	3	4		267	261	244	226	214	187	153	133	112
VSP SN 04015/35	35	3,7	5		334	326	305	282	268	233	191	166	139

## Performans Eğrileri / Performance Curves

www.vansan.com.tr

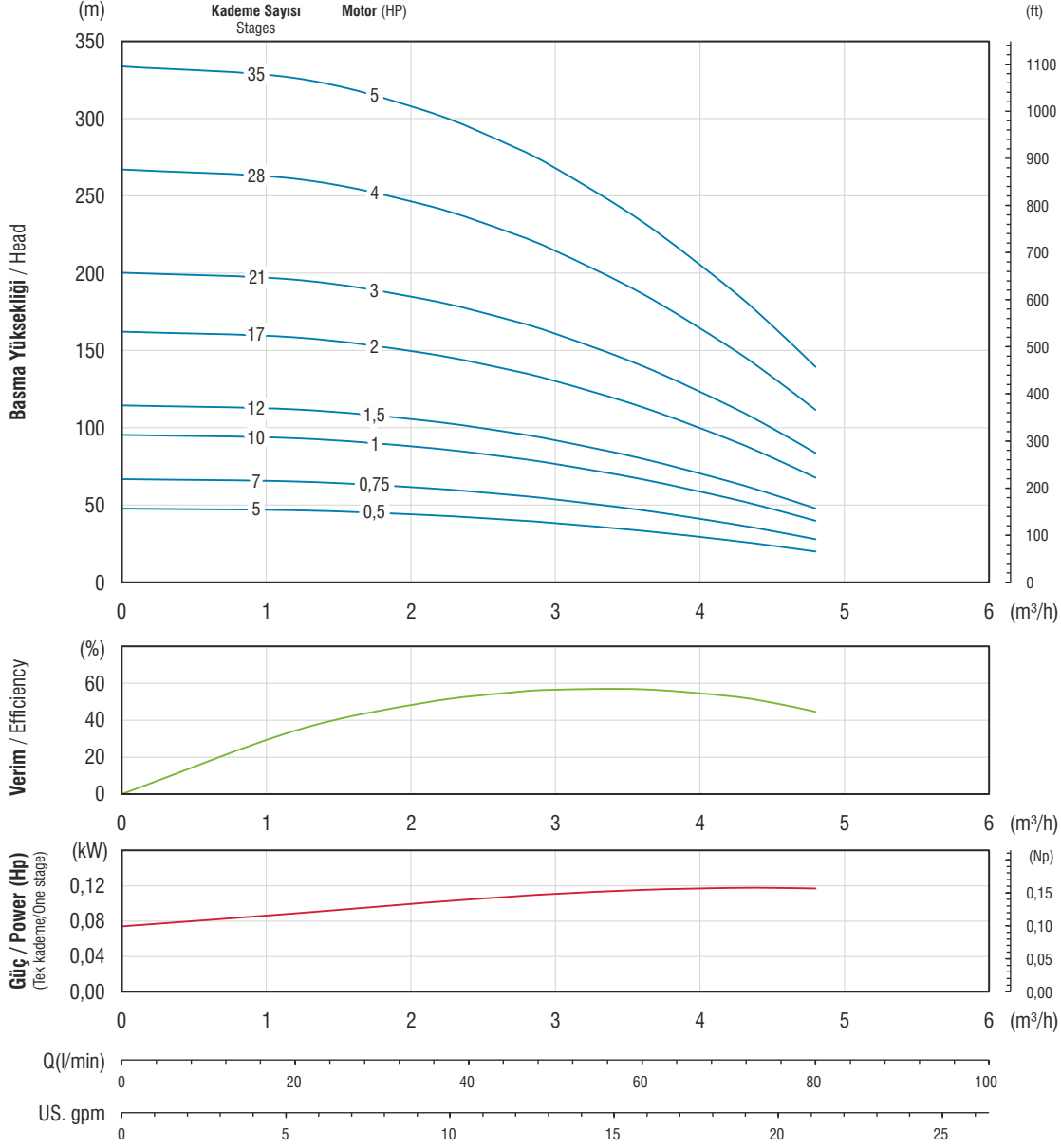

# VSP SN 04015 (60Hz)

Çark kanat sayısı / No. of vanes  
6

Çıkış haznesi bağlantısı / Outlet connection diameter  
BSP / NPT 1¼"

Pompa dış çapı / Pump outside diameter  
98 mm (kablo koruması dahil / Including cable guard)

Dönüş Yönü / Rotation  
Saatin tersi yönünde / CCW

Devir / Revolution  
3500 rpm

Mil çapı / Shaft diameter  
11 mm



Pompa performans eğrileri 1 bar atmosfer basıncı altında 15°C sıcaklığındaki, özgül yoğunluğu 1 gr/cm³ olan su ile elde edilmiştir.  
The hydraulic working characteristics have been taken with water at 15 °C, at the atmospheric pressure of 1 bar and specific gravity is 1 gr/cm³

# Teknik Özellikler

## Technical specifications

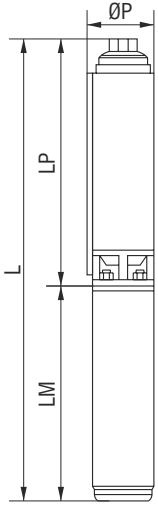

**Çark** : Noril  
**Impeller** : Noryl

**Difüzör** : PC, %20 Cam Elyaf Takviyeli, Naturel  
**Diffuser** : PC, 20% Glass Fiber Reinforced, Natural

**Süzgeç** : Paslanmaz çelik (AISI 304)  
**Strainer** : Stainless steel (AISI 304)

**Kaplin** : Paslanmaz çelik (AISI 316)  
**Coupling** : Stainless steel (AISI 316)

**Klepe** : Paslanmaz çelik (AISI 304)  
**Valve cap** : Stainless steel (AISI 304)

**Ara parça** : Noril  
**Valve Housing** : Noryl

**Pompa mili** : Paslanmaz çelik (AISI 420)  
**Pump shaft** : Stainless steel (AISI 420)

**Emiş haznesi** : Paslanmaz çelik (AISI 304)  
**Suction case** : Stainless steel (AISI 304)

**Çıkış haznesi** : Paslanmaz çelik (AISI 304)  
**Top bracket** : Stainless steel (AISI 304)

**Difüzör haznesi** : Paslanmaz çelik (AISI 304)  
**Diffuser casing** : Stainless steel (AISI 304)



## Ölçü ve Ağırlıklar / Dimensions & Weights

Pompa Tipi Pump type	Kad. Sayısı Stages	Motor		Ölçüler / Dimensions (mm)						Ağırlık / Weight (kg)				
		kW	HP	ØP	LP	Monofaze / 1ph.		Trifaze / 3ph.		Pompa Pump	Monofaze / 1ph.		Trifaze / 3ph.	
						LM	L	LM	L		Motor	Total	Motor	Total
VSP SN 04020/5	5	0,37	0,5	98	257	361	618	346	603	2,8	8,6	11,4	7,7	10,5
VSP SN 04020/6	6	0,55	0,75	98	279	381	660	361	640	2,9	9,3	12,2	8,5	11,4
VSP SN 04020/8	8	0,75	1	98	322	401	723	381	703	3,2	10,4	13,6	9,5	12,7
VSP SN 04020/11	11	1,1	1,5	98	387	441	828	401	788	3,7	12,2	15,9	10,4	14,1
VSP SN 04020/14	14	1,5	2	98	462	471	933	441	903	4,2	13,7	17,9	12,4	16,6
VSP SN 04020/19	19	2,2	3	98	560	561	1.121	471	1.031	5,0	18,0	23,0	13,9	18,9
VSP SN 04020/25	25	3	4	98	763	-	-	530	1.293	7,1	-	-	16,2	23,3
VSP SN 04020/30	30	3,7	5	98	865	-	-	595	1.460	8,3	-	-	19,5	27,8

## Performans Tablosu / Performance Table

Pompa Tipi Pump type	Kad. Sayısı Stages	Motor		m <sup>3</sup> /h l/min	0	2,1	3,0	3,6	4,2	4,8	5,4	6,0	6,6
		kW	HP		0	35	50	60	70	80	90	100	110
VSP SN 04020/5	5	0,37	0,5	Basma Yüksekliği / Head (m)	46	43	40	38	35	31	27	22	17
VSP SN 04020/6	6	0,55	0,75		55	52	48	45	42	37	32	27	20
VSP SN 04020/8	8	0,75	1		74	69	64	60	55	50	43	36	27
VSP SN 04020/11	11	1,1	1,5		101	94	88	83	76	69	59	49	37
VSP SN 04020/14	14	1,5	2		129	120	112	105	97	87	76	62	47
VSP SN 04020/19	19	2,2	3		175	163	153	143	132	118	103	85	64
VSP SN 04020/25	25	3	4		230	215	201	188	173	156	135	112	85
VSP SN 04020/30	30	3,7	5		276	258	241	226	208	187	162	134	101

## Performans Eğrileri / Performance Curves

www.vansan.com.tr

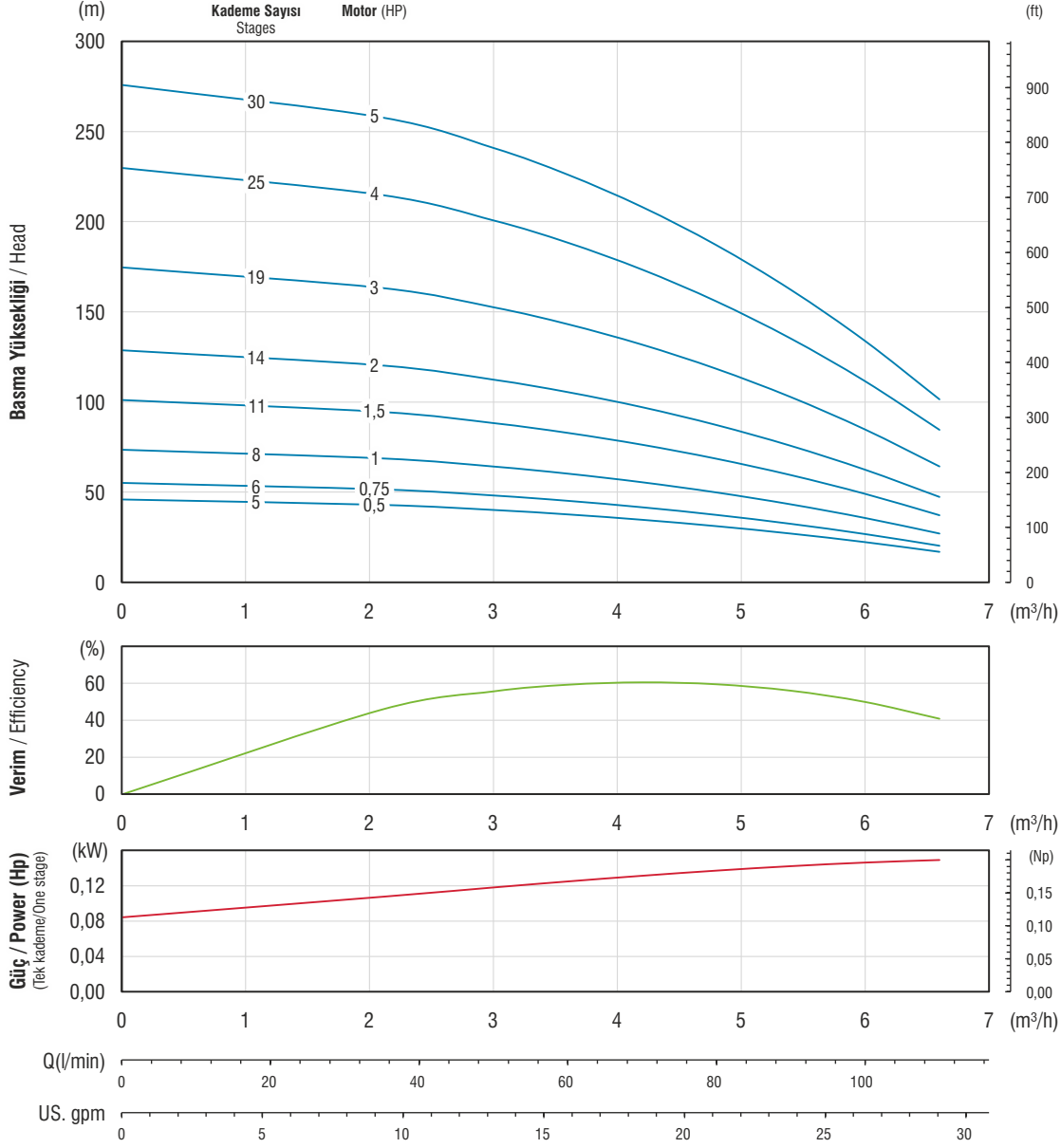

# VSP SN 04020 (60Hz)

Çark kanat sayısı / No. of vanes  
7

Çıkış haznesi bağlantısı / Outlet connection diameter  
BSP / NPT 1¼"

Pompa dış çapı / Pump outside diameter  
98 mm (kablo koruması dahil / Including cable guard)

Dönüş Yönü / Rotation  
Saatin tersi yönünde / CCW

Devir / Revolution  
3500 rpm

Mil çapı / Shaft diameter  
11 mm



Pompa performans eğrileri 1 bar atmosfer basıncı altında 15°C sıcaklığındaki, özgül yoğunluğu 1 gr/cm³ olan su ile elde edilmiştir.  
The hydraulic working characteristics have been taken with water at 15 °C, at the atmospheric pressure of 1 bar and specific gravity is 1 gr/cm³

# Teknik Özellikler

## Technical specifications

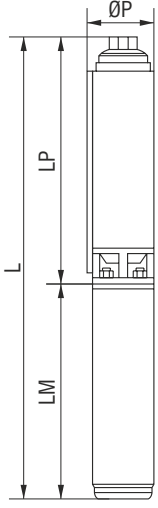

**Çark** : Noril  
**Impeller** : Noryl  
**Difüzör** : PC, %20 Cam Elyaf Takviyeli, Naturel  
**Diffuser** : PC, 20% Glass Fiber Reinforced, Natural  
**Süzgeç** : Paslanmaz çelik (AISI 304)  
**Strainer** : Stainless steel (AISI 304)  
**Kaplin** : Paslanmaz çelik (AISI 316)  
**Coupling** : Stainless steel (AISI 316)  
**Klepe** : Paslanmaz çelik (AISI 304)  
**Valve cap** : Stainless steel (AISI 304)

**Ara parça** : Noril  
**Valve Housing** : Noryl  
**Pompa mili** : Paslanmaz çelik (AISI 420)  
**Pump shaft** : Stainless steel (AISI 420)  
**Emiş haznesi** : Paslanmaz çelik (AISI 304)  
**Suction case** : Stainless steel (AISI 304)  
**Çıkış haznesi** : Paslanmaz çelik (AISI 304)  
**Top bracket** : Stainless steel (AISI 304)  
**Difüzör haznesi** : Paslanmaz çelik (AISI 304)  
**Diffuser casing** : Stainless steel (AISI 304)



## Ölçü ve Ağırlıklar / Dimensions & Weights

Pompa Tipi Pump type	Kad. Sayısı Stages	Motor		Ölçüler / Dimensions (mm)						Ağırlık / Weight (kg)				
		kW	HP	ØP	LP	Monofaze / 1ph.		Trifaze / 3ph.		Pompa Pump	Monofaze / 1ph.		Trifaze / 3ph.	
						LM	L	LM	L		Motor	Total	Motor	Total
VSP SN 04025/4	4	0,37	0,5	98	249	361	610	346	595	2,5	8,6	11,1	7,7	10,2
VSP SN 04025/5	5	0,55	0,75	98	275	381	656	361	636	2,7	9,3	12,0	8,5	11,2
VSP SN 04025/7	7	0,75	1	98	323	401	724	381	704	3,2	10,4	13,6	9,5	12,7
VSP SN 04025/9	9	1,1	1,5	98	374	441	815	401	775	3,6	12,2	15,8	10,4	14,0
VSP SN 04025/11	11	1,5	2	98	423	471	894	441	864	4,1	13,7	17,8	12,4	16,5
VSP SN 04025/15	15	2,2	3	98	523	561	1084	471	994	4,9	18,0	22,9	13,9	18,8
VSP SN 04025/20	20	3	4	98	686	-	-	530	1.216	6,0	-	-	16,2	22,2
VSP SN 04025/26	26	3,7	5	98	873	-	-	595	1.468	8,4	-	-	19,5	27,9

## Performans Tablosu / Performance Table

Pompa Tipi Pump type	Kad. Sayısı Stages	Motor		m <sup>3</sup> /h l/min	0	1,8	3,0	3,6	4,2	4,8	5,4	6,0	7,2
		kW	HP		0	30	50	60	70	80	90	100	120
VSP SN 04025/4	4	0,37	0,5	Basma Yüksekliği / Head (m)	37	35	33	32	30	28	25	22	15
VSP SN 04025/5	5	0,55	0,75		46	44	42	40	37	35	32	28	19
VSP SN 04025/7	7	0,75	1		64	62	58	56	52	49	44	39	26
VSP SN 04025/9	9	1,1	1,5		83	80	75	72	67	63	57	50	34
VSP SN 04025/11	11	1,5	2		101	98	92	87	82	76	70	61	42
VSP SN 04025/15	15	2,2	3		138	133	125	119	112	104	95	84	57
VSP SN 04025/20	20	3	4		184	177	167	159	150	139	126	112	76
VSP SN 04025/26	26	3,7	5		239	231	217	207	195	181	164	145	98



## Performans Eğrileri / Performance Curves

www.vansan.com.tr

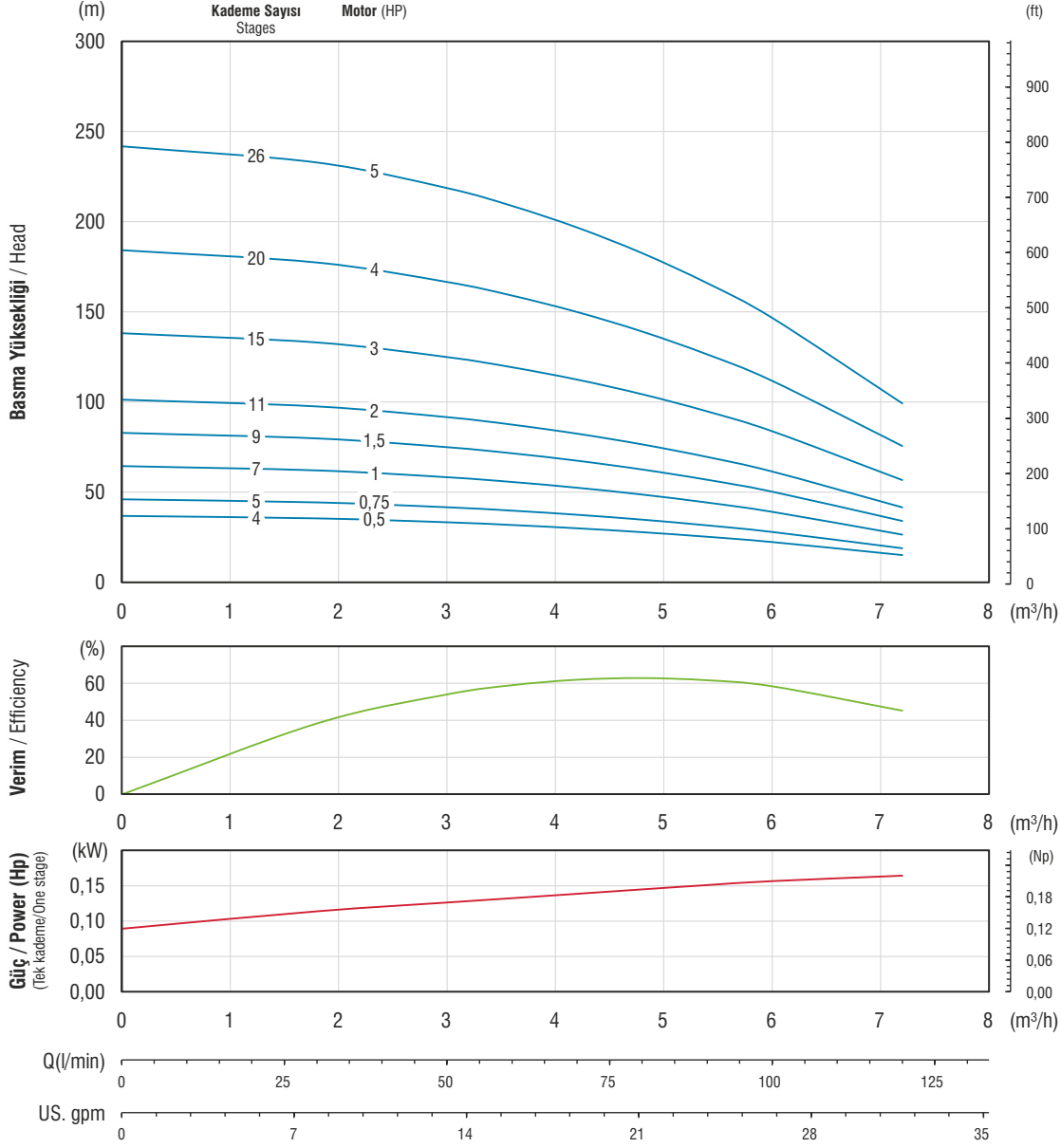

# VSP SN 04025 (60Hz)

Çark kanat sayısı / No. of vanes  
7

Çıkış haznesi bağlantısı / Outlet connection diameter  
BSP / NPT 1¼"

Pompa dış çapı / Pump outside diameter  
98 mm (kablo koruması dahil / Including cable guard)

Dönüş Yönü / Rotation  
Saatin tersi yönünde / CCW

Devir / Revolution  
3500 rpm

Mil çapı / Shaft diameter  
11 mm



Pompa performans eğrileri 1 bar atmosfer basıncı altında 15°C sıcaklığındaki, özgül yoğunluğu 1 gr/cm³ olan su ile elde edilmiştir.  
The hydraulic working characteristics have been taken with water at 15 °C, at the atmospheric pressure of 1 bar and specific gravity is 1 gr/cm³

# Teknik Özellikler

## Technical specifications

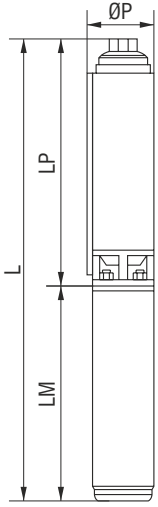

**Çark** : Noril  
**Impeller** : Noryl

**Difüzör** : PC, %20 Cam Elyaf Takviyeli, Naturel  
**Diffuser** : PC, 20% Glass Fiber Reinforced, Natural

**Süzgeç** : Paslanmaz çelik (AISI 304)  
**Strainer** : Stainless steel (AISI 304)

**Kaplin** : Paslanmaz çelik (AISI 316)  
**Coupling** : Stainless steel (AISI 316)

**Klepe** : Paslanmaz çelik (AISI 304)  
**Valve cap** : Stainless steel (AISI 304)

**Ara parça** : Noril  
**Valve Housing** : Noryl

**Pompa mili** : Paslanmaz çelik (AISI 420)  
**Pump shaft** : Stainless steel (AISI 420)

**Emiş haznesi** : Paslanmaz çelik (AISI 304)  
**Suction case** : Stainless steel (AISI 304)

**Çıkış haznesi** : Paslanmaz çelik (AISI 304)  
**Top bracket** : Stainless steel (AISI 304)

**Difüzör haznesi** : Paslanmaz çelik (AISI 304)  
**Diffuser casing** : Stainless steel (AISI 304)



## Ölçü ve Ağırlıklar / Dimensions & Weights

Pompa Tipi Pump type	Kad. Sayısı Stages	Motor		Ölçüler / Dimensions (mm)						Ağırlık / Weight (kg)				
		kW	HP	ØP	LP	Monofaze / 1ph.		Trifaze / 3ph.		Pompa Pump	Monofaze / 1ph.		Trifaze / 3ph.	
						LM	L	LM	L		Motor	Total	Motor	Total
VSP SN 04030/6	6	0,75	1	98	363	401	764	381	744	3,6	10,4	14,0	9,5	13,1
VSP SN 04030/8	8	1,1	1,5	98	425	441	866	401	826	4,2	12,2	16,4	10,4	14,6
VSP SN 04030/10	10	1,5	2	98	488	471	959	441	929	4,8	13,7	18,5	12,4	17,2
VSP SN 04030/14	14	2,2	3	98	613	561	1174	471	1.084	6,0	18,0	24,0	13,9	19,9
VSP SN 04030/18	18	3	4	98	738	-	-	530	1.268	7,2	-	-	16,2	23,4
VSP SN 04030/22	22	3,7	5	98	902	-	-	595	1.497	8,5	-	-	19,5	28,0
VSP SN 04030/24	24	4	5,5	98	1003	-	-	600	1.603	10,2	-	-	19,7	29,9
VSP SN 04030/34	34	5,5	7,5	98	1308	-	-	655	1.963	13,2	-	-	22,5	35,7
VSP SN 04030/43	43	7,5	10	98	1370	-	-	795	2.165	16,0	-	-	28,8	44,8

## Performans Tablosu / Performance Table

Pompa Tipi Pump type	Kad. Sayısı Stages	Motor		m <sup>3</sup> /h l/min	0	3,6	4,8	5,4	6,0	7,2	8,4	9,6	10,8
		kW	HP		0	60	80	90	100	120	140	160	180
VSP SN 04030/6	6	0,75	1	Basma Yüksekliği / Head (m)	52	46	43	41	39	34	28	20	12
VSP SN 04030/8	8	1,1	1,5		70	61	58	55	52	46	37	27	16
VSP SN 04030/10	10	1,5	2		87	77	72	69	65	57	47	34	20
VSP SN 04030/14	14	2,2	3		122	107	101	96	92	80	65	48	28
VSP SN 04030/18	18	3	4		157	138	129	124	118	103	84	61	35
VSP SN 04030/22	22	3,7	5		192	169	158	152	144	126	102	75	43
VSP SN 04030/24	24	4	5,5		209	184	173	165	157	137	112	82	47
VSP SN 04030/34	34	5,5	7,5		297	261	244	234	223	194	158	116	67
VSP SN 04030/43	43	7,5	10		375	329	309	296	281	245	200	146	85

## Performans Eğrileri / Performance Curves

www.vansan.com.tr

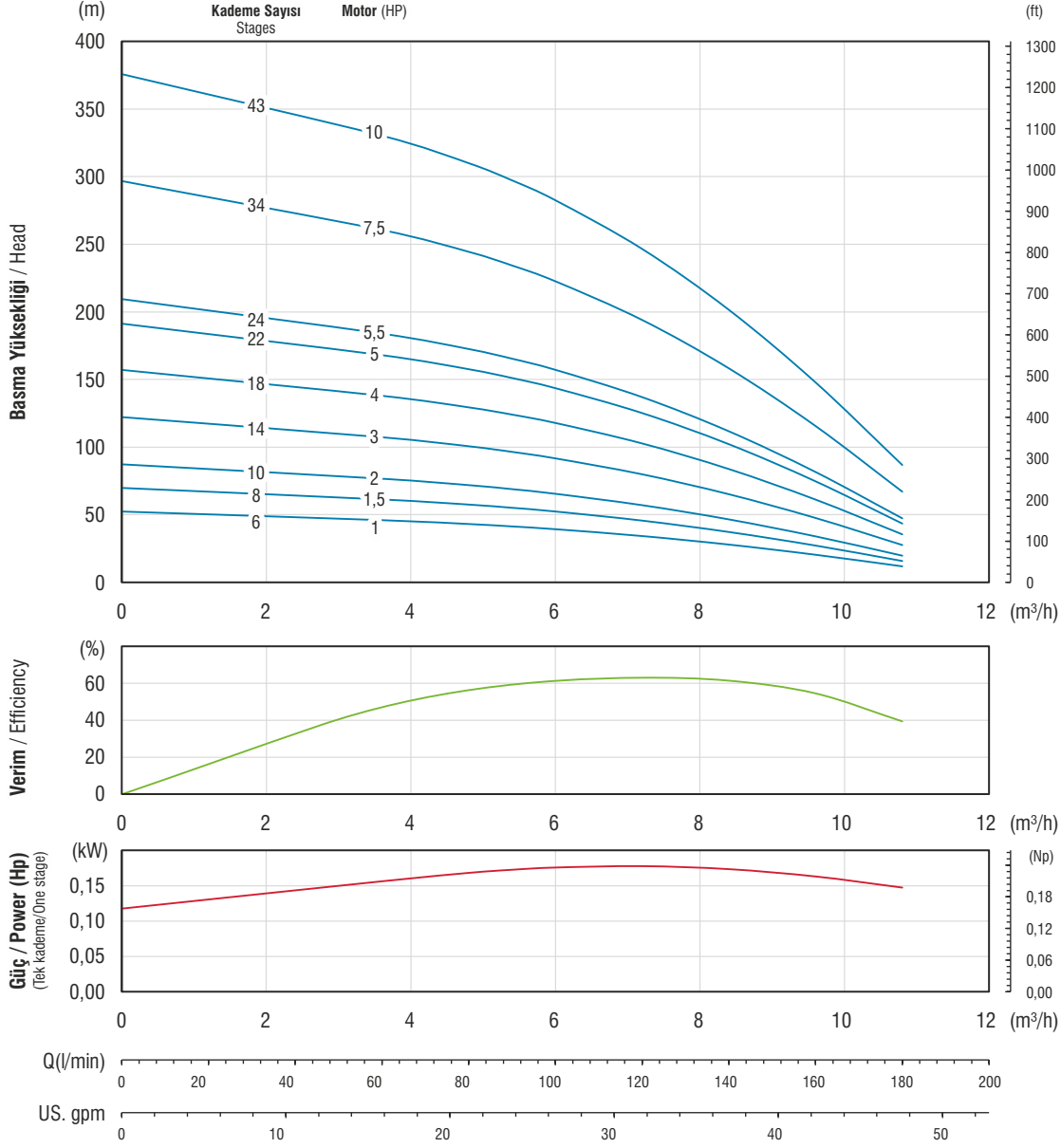

# VSP SN 04030 (60Hz)

Çark kanat sayısı / No. of vanes  
6

Çıkış haznesi bağlantısı / Outlet connection diameter  
BSP / NPT 2"

Pompa dış çapı / Pump outside diameter  
98 mm (kablo koruması dahil / Including cable guard)

Dönüş Yönü / Rotation  
Saatın tersi yönünde / CCW

Devir / Revolution  
3500 rpm

Mil çapı / Shaft diameter  
11 mm



Pompa performans eğrileri 1 bar atmosfer basıncı altında 15°C sıcaklığındaki, özgül yoğunluğu 1 gr/cm³ olan su ile elde edilmiştir.  
The hydraulic working characteristics have been taken with water at 15 °C, at the atmospheric pressure of 1 bar and specific gravity is 1 gr/cm³

# Teknik Özellikler

## Technical specifications

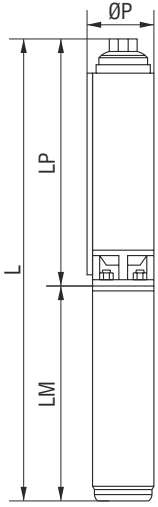

**Çark** : Noril  
**Impeller** : Noryl

**Difüzör** : PC, %20 Cam Elyaf Takviyeli, Naturel  
**Diffuser** : PC, 20% Glass Fiber Reinforced, Natural

**Süzgeç** : Paslanmaz çelik (AISI 304)  
**Strainer** : Stainless steel (AISI 304)

**Kaplin** : Paslanmaz çelik (AISI 316)  
**Coupling** : Stainless steel (AISI 316)

**Klepe** : Paslanmaz çelik (AISI 304)  
**Valve cap** : Stainless steel (AISI 304)

**Ara parça** : Noril  
**Valve Housing** : Noryl

**Pompa mili** : Paslanmaz çelik (AISI 420)  
**Pump shaft** : Stainless steel (AISI 420)

**Emiş haznesi** : Paslanmaz çelik (AISI 304)  
**Suction case** : Stainless steel (AISI 304)

**Çıkış haznesi** : Paslanmaz çelik (AISI 304)  
**Top bracket** : Stainless steel (AISI 304)

**Difüzör haznesi** : Paslanmaz çelik (AISI 304)  
**Diffuser casing** : Stainless steel (AISI 304)



## Ölçü ve Ağırlıklar / Dimensions & Weights

Pompa Tipi Pump type	Kad. Sayısı Stages	Motor		Ölçüler / Dimensions (mm)						Ağırlık / Weight (kg)				
		kW	HP	ØP	LP	Monofaze / 1ph.		Trifaze / 3ph.		Pompa Pump	Monofaze / 1ph.		Trifaze / 3ph.	
						LM	L	LM	L		Motor	Total	Motor	Total
VSP SN 04040/5	5	1,1	1,5	98	328	441	769	401	729	3,3	12,2	15,5	10,4	13,7
VSP SN 04040/6	6	1,5	2	98	362	471	833	441	803	3,6	13,7	17,3	12,4	16,0
VSP SN 04040/8	8	2,2	3	98	422	561	983	471	893	4,3	18,0	22,3	13,9	18,2
VSP SN 04040/11	11	3	4	98	516	-	-	530	1.046	5,2	-	-	16,2	21,4
VSP SN 04040/14	14	3,7	5	98	610	-	-	595	1.205	6,1	-	-	19,5	25,6
VSP SN 04040/15	15	4	5,5	98	644	-	-	600	1.244	6,4	-	-	19,7	26,1
VSP SN 04040/21	21	5,5	7,5	98	868	-	-	655	1.523	8,3	-	-	22,5	30,8
VSP SN 04040/28	28	7,5	10	98	1.146	-	-	795	1.941	11,6	-	-	28,8	40,4

## Performans Tablosu / Performance Table

Pompa Tipi Pump type	Kad. Sayısı Stages	Motor		m <sup>3</sup> /h l/min	0	4,8	6,0	7,2	8,4	9,6	10,8	12,0	15,0
		kW	HP		0	80	100	120	140	160	180	200	250
VSP SN 04040/5	5	1,1	1,5	Basma Yüksekliği / Head (m)	46	43	41	39	37	35	31	28	14
VSP SN 04040/6	6	1,5	2		55	51	49	47	45	41	38	33	17
VSP SN 04040/8	8	2,2	3		74	68	66	63	59	55	50	44	23
VSP SN 04040/11	11	3	4		101	94	90	87	82	76	69	61	31
VSP SN 04040/14	14	3,7	5		129	119	115	110	104	97	88	77	40
VSP SN 04040/15	15	4	5,5		138	128	123	118	111	104	94	83	43
VSP SN 04040/21	21	5,5	7,5		193	179	173	165	156	145	132	116	60
VSP SN 04040/28	28	7,5	10		257	239	230	220	208	193	176	154	80

## Performans Eğrileri / Performance Curves

www.vansan.com.tr

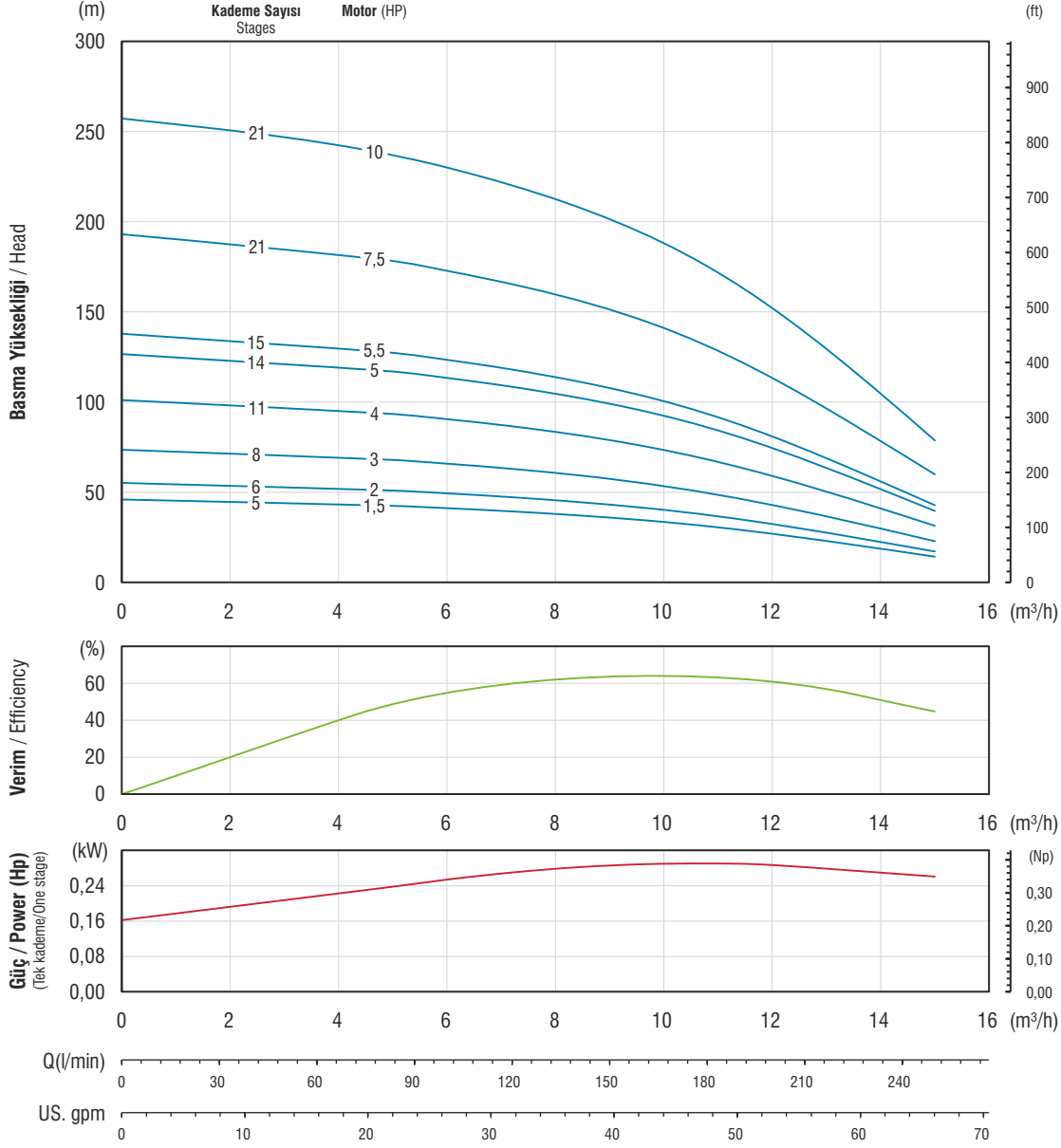

# VSP SN 04040 (60Hz)

Çark kanat sayısı / No. of vanes  
7

Çıkış haznesi bağlantısı / Outlet connection diameter  
BSP / NPT 2"

Pompa dış çapı / Pump outside diameter  
98 mm (kablo koruması dahil / Including cable guard)

Dönüş Yönü / Rotation  
Saatin tersi yönünde / CCW

Devir / Revolution  
3500 rpm

Mil çapı / Shaft diameter  
11 mm



Pompa performans eğrileri 1 bar atmosfer basıncı altında 15°C sıcaklığındaki, özgül yoğunluğu 1 gr/cm³ olan su ile elde edilmiştir.  
The hydraulic working characteristics have been taken with water at 15 °C, at the atmospheric pressure of 1 bar and specific gravity is 1 gr/cm³

# Teknik Özellikler

## Technical specifications

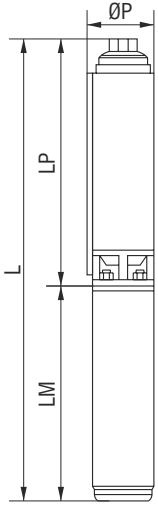

**Çark** : Noril  
**Impeller** : Noryl

**Difüzör** : PC, %20 Cam Elyaf Takviyeli, Naturel  
**Diffuser** : PC, 20% Glass Fiber Reinforced, Natural

**Süzgeç** : Paslanmaz çelik (AISI 304)  
**Strainer** : Stainless steel (AISI 304)

**Kaplin** : Paslanmaz çelik (AISI 316)  
**Coupling** : Stainless steel (AISI 316)

**Klepe** : Paslanmaz çelik (AISI 304)  
**Valve cap** : Stainless steel (AISI 304)

**Ara parça** : Noril  
**Valve Housing** : Noryl

**Pompa mili** : Paslanmaz çelik (AISI 420)  
**Pump shaft** : Stainless steel (AISI 420)

**Emiş haznesi** : Paslanmaz çelik (AISI 304)  
**Suction case** : Stainless steel (AISI 304)

**Çıkış haznesi** : Paslanmaz çelik (AISI 304)  
**Top bracket** : Stainless steel (AISI 304)

**Difüzör haznesi** : Paslanmaz çelik (AISI 304)  
**Diffuser casing** : Stainless steel (AISI 304)



## Ölçü ve Ağırlıklar / Dimensions & Weights

Pompa Tipi Pump type	Kad. Sayısı Stages	Motor		Ölçüler / Dimensions (mm)						Ağırlık / Weight (kg)				
		kW	HP	ØP	LP	Monofaze / 1ph.		Trifaze / 3ph.		Pompa Pump	Monofaze / 1ph.		Trifaze / 3ph.	
						LM	L	LM	L		Motor	Total	Motor	Total
VSP SN 04060/4	4	1,1	1,5	98	389	441	830	401	790	4,2	12,2	16,4	10,4	14,6
VSP SN 04060/5	5	1,5	2	98	443	471	914	441	884	4,8	13,7	18,5	12,4	17,2
VSP SN 04060/7	7	2,2	3	98	550	561	1.111	471	1.021	5,7	18,0	23,7	13,9	19,6
VSP SN 04060/9	9	3	4	98	657	-	-	530	1.187	6,8	-	-	16,2	23,0
VSP SN 04060/11	11	3,7	5	98	764	-	-	595	1.359	7,8	-	-	19,5	27,3
VSP SN 04060/12	12	4	5,5	98	821	-	-	600	1.421	8,3	-	-	19,7	28,0
VSP SN 04060/17	17	5,5	7,5	98	1.125	-	-	655	1.780	10,9	-	-	22,5	33,4
VSP SN 04060/23	23	7,5	10	98	1.493	-	-	795	2.288	15,3	-	-	28,8	44,1

## Performans Tablosu / Performance Table

Pompa Tipi Pump type	Kad. Sayısı Stages	Motor		m <sup>3</sup> /h l/min	0	6,0	9,6	12,0	14,4	15,6	16,8	18,0	19,2
		kW	HP		0	100	160	200	240	260	280	300	320
VSP SN 04060/4	4	1,1	1,5	Basma Yüksekliği / Head (m)	36	32	28	25	21	18	15	12	9
VSP SN 04060/5	5	1,5	2		45	41	35	31	26	23	19	15	11
VSP SN 04060/7	7	2,2	3		63	57	50	43	36	32	27	21	15
VSP SN 04060/9	9	3	4		82	73	64	56	46	41	34	27	20
VSP SN 04060/11	11	3,7	5		100	89	78	68	56	50	42	33	24
VSP SN 04060/12	12	4	5,5		109	97	85	75	62	54	46	37	26
VSP SN 04060/17	17	5,5	7,5		154	138	121	106	87	77	65	52	37
VSP SN 04060/23	23	7,5	10		208	186	163	143	118	104	88	70	50

## Performans Eğrileri / Performance Curves

www.vansan.com.tr

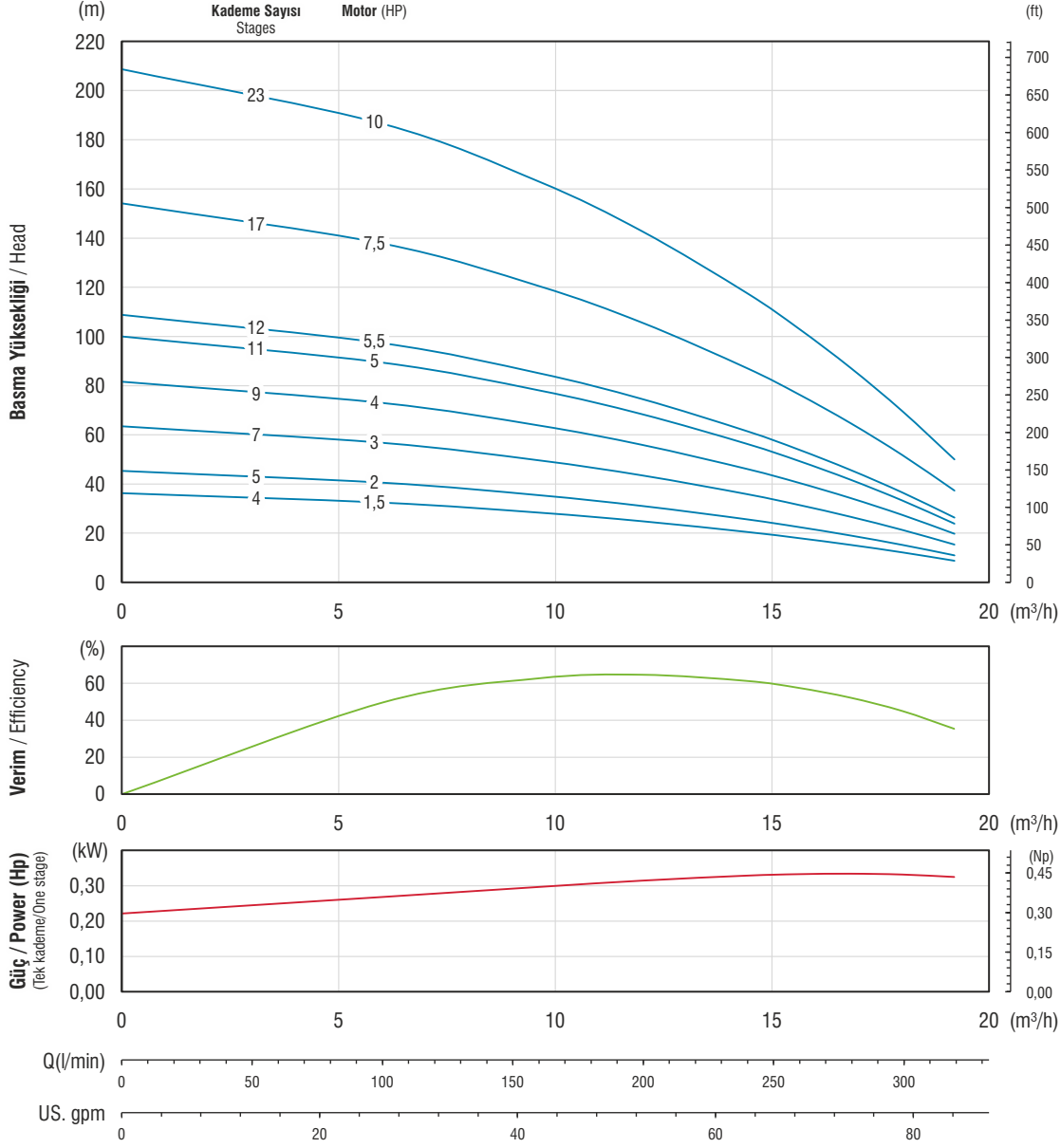

# VSP SN 04060 (60Hz)

Çark kanat sayısı / No. of vanes  
6

Çıkış haznesi bağlantısı / Outlet connection diameter  
BSP / NPT 2"

Pompa dış çapı / Pump outside diameter  
98 mm (kablo koruması dahil / Including cable guard)

Dönüş Yönü / Rotation  
Saatin tersi yönünde / CCW

Devir / Revolution  
3500 rpm

Mil çapı / Shaft diameter  
11 mm



Pompa performans eğrileri 1 bar atmosfer basıncı altında 15°C sıcaklığındaki, özgül yoğunluğu 1 gr/cm³ olan su ile elde edilmiştir.  
The hydraulic working characteristics have been taken with water at 15 °C, at the atmospheric pressure of 1 bar and specific gravity is 1 gr/cm³

# Teknik Özellikler

## Technical specifications

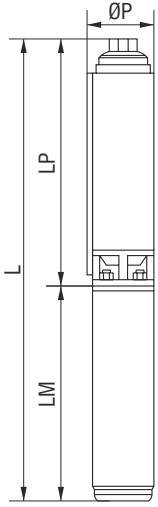

**Çark** : Noril  
**Impeller** : Noryl  
**Difüzör** : PC, %20 Cam Elyaf Takviyeli, Naturel  
**Diffuser** : PC, 20% Glass Fiber Reinforced, Natural  
**Süzgeç** : Paslanmaz çelik (AISI 304)  
**Strainer** : Stainless steel (AISI 304)  
**Kaplin** : Paslanmaz çelik (AISI 316)  
**Coupling** : Stainless steel (AISI 316)  
**Klepe** : Paslanmaz çelik (AISI 304)  
**Valve cap** : Stainless steel (AISI 304)

**Ara parça** : Noril  
**Valve Housing** : Noryl  
**Pompa mili** : Paslanmaz çelik (AISI 420)  
**Pump shaft** : Stainless steel (AISI 420)  
**Emiş haznesi** : Paslanmaz çelik (AISI 304)  
**Suction case** : Stainless steel (AISI 304)  
**Çıkış haznesi** : Paslanmaz çelik (AISI 304)  
**Top bracket** : Stainless steel (AISI 304)  
**Difüzör haznesi** : Paslanmaz çelik (AISI 304)  
**Diffuser casing** : Stainless steel (AISI 304)



## Ölçü ve Ağırlıklar / Dimensions & Weights

Pompa Tipi Pump type	Kad. Sayısı Stages	Motor		Ölçüler / Dimensions (mm)						Ağırlık / Weight (kg)				
		kW	HP	ØP	LP	Monofaze / 1ph.		Trifaze / 3ph.		Pompa Pump	Monofaze / 1ph.		Trifaze / 3ph.	
						LM	L	LM	L		Motor	Total	Motor	Total
VSP SN 04080/4	4	2,2	3	98	408	561	969	471	879	3,9	18,0	21,9	13,9	17,8
VSP SN 04080/6	6	3	4	98	545	-	-	530	1.075	5,2	-	-	16,2	21,4
VSP SN 04080/8	8	3,7	5	98	683	-	-	595	1.278	6,5	-	-	19,5	26,0
VSP SN 04080/9	9	4	5,5	98	750	-	-	600	1.350	7,1	-	-	19,7	26,8
VSP SN 04080/13	13	5,5	7,5	98	1.023	-	-	655	1.678	9,6	-	-	22,5	32,1
VSP SN 04080/17	17	7,5	10	98	1.298	-	-	795	2.093	12,1	-	-	28,8	40,9

## Performans Tablosu / Performance Table

Pompa Tipi Pump type	Kad. Sayısı Stages	Motor		m <sup>3</sup> /h l/min	0	9,6	13,2	16,8	18,0	20,4	22,8	25,2	27,6
		kW	HP		0	160	220	280	300	340	380	420	460
VSP SN 04080/4	4	2,2	3	Basma Yüksekliği / Head (m)	35	30	27	24	23	20	17	15	11
VSP SN 04080/6	6	3	4		52	46	41	36	34	30	26	22	17
VSP SN 04080/8	8	3,7	5		70	61	55	48	45	40	35	29	23
VSP SN 04080/9	9	4	5,5		78	69	62	54	51	45	39	33	26
VSP SN 04080/13	13	5,5	7,5		113	99	89	78	74	65	57	47	37
VSP SN 04080/17	17	7,5	10		148	130	117	102	96	86	74	62	49



## Performans Eğrileri / Performance Curves

www.vansan.com.tr

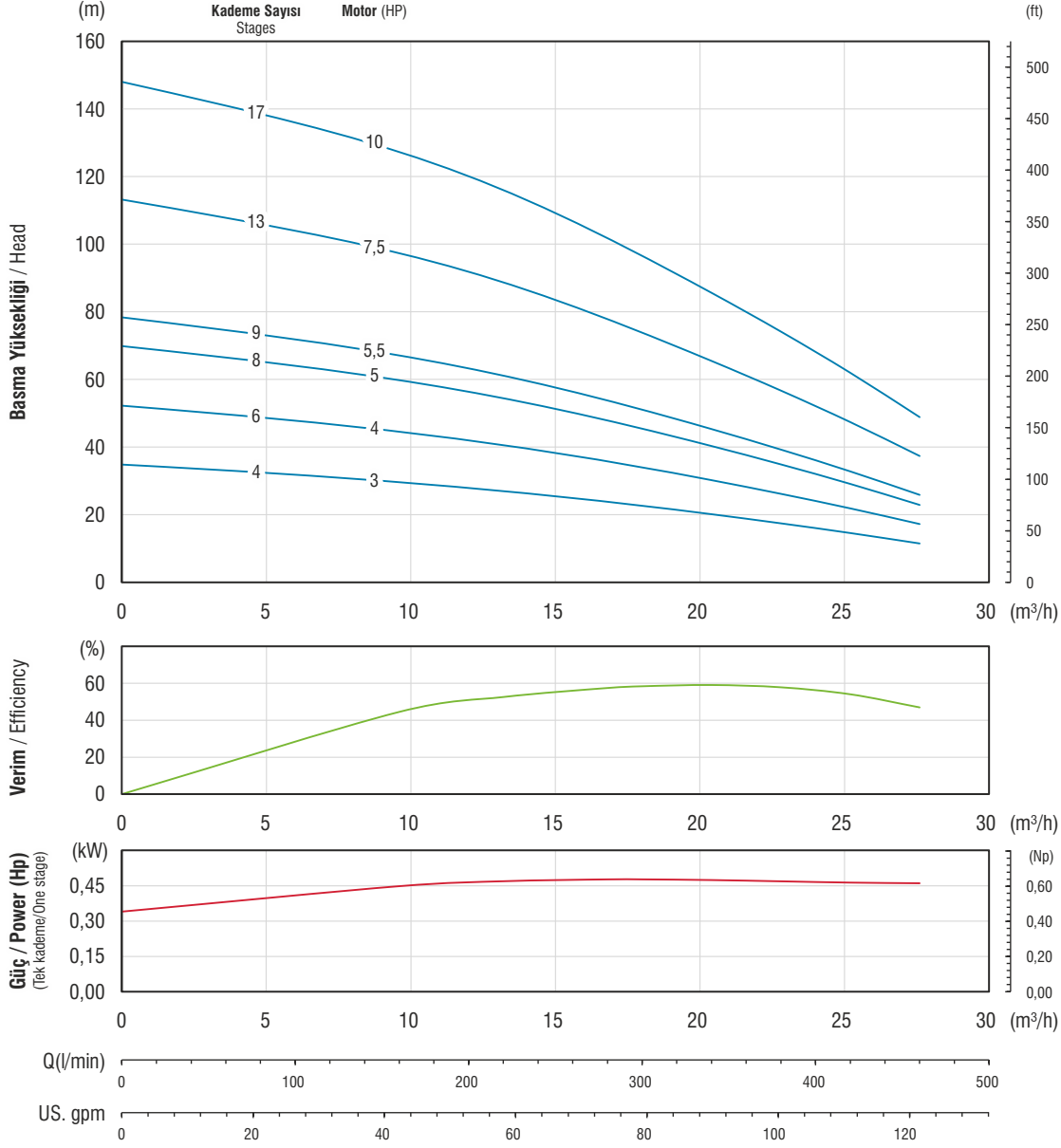

# VSP SN 04080 (60Hz)

Çark kanat sayısı / No. of vanes  
6

Çıkış haznesi bağlantısı / Outlet connection diameter  
BSP / NPT 2"

Pompa dış çapı / Pump outside diameter  
98 mm (kablo koruması dahil / Including cable guard)

Dönüş Yönü / Rotation  
Saatın tersi yönünde / CCW

Devir / Revolution  
3500 rpm

Mil çapı / Shaft diameter  
11 mm

Pompa performans eğrileri 1 bar atmosfer basıncı altında 15°C sıcaklığındaki, özgül yoğunluğu 1 gr/cm³ olan su ile elde edilmiştir.  
The hydraulic working characteristics have been taken with water at 15 °C, at the atmospheric pressure of 1 bar and specific gravity is 1 gr/cm³



**Notlar:**

A series of horizontal dotted lines for writing notes.



10035 Sk. No:10 A.O.S.B. 35620 - Cigli, Izmir / TURKEY  
T: +90 (232) 376 76 50 • F: +90 (232) 328 01 68  
www.vansan.com.tr • vansan@vansan.com.tr

